

# TCM Series

In their basic version the TCM Series horizontal centre lathes – thanks to the innovative mechanical solutions and the advanced control systems – are the multipurpose lathes that guarantee productive rough and finish machining. The construction of the lathe is based on a rigid bed with hardened guides with full support on the ground and with chip spout on its back. The construction of these solid lathes is also characterized by solutions which ensure good vibration damping and excellent rigidity. The result of it is high accuracy, repeatability and excellent finishing of the machined surfaces while maintaining reliability. A wide range of additional equipment allows further increase of machining efficiency.

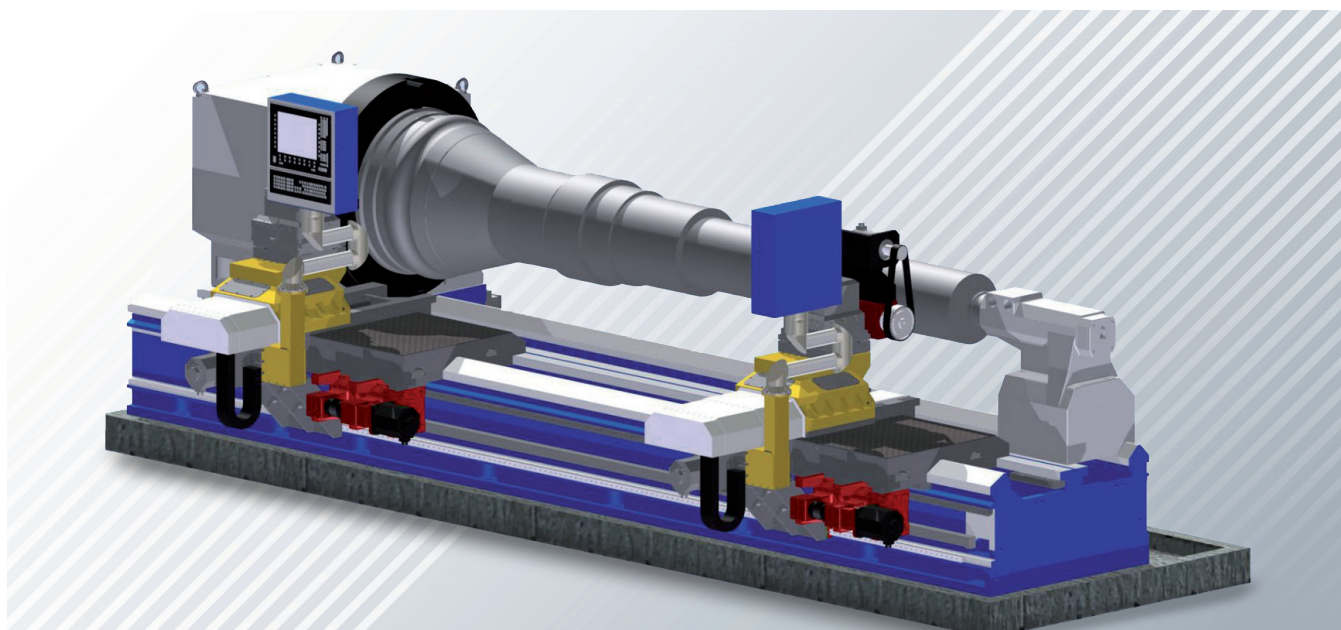

Centre Lathes



## Main features:

- Machine tool construction based on a rigid bed with hardened guideways
- 3-guideway bed, headstock body made from high-grade cast iron of enhanced mechanical properties
- Carriage travels along two guideways that guarantee precise guidance
- Spindle rested on bearings of increased accuracy class
- A wide variety of optional equipment that expands the machine tool capabilities
- All shafts and gears carburized, hardened and ground

TECHNICAL SPECIFICATIONS		TCM 130 CNC	TCM 155 CNC	TCM 180 CNC
<b>Capacity</b>				
Swing over bed	∅ mm	1300	1550	1800
Swing over carriage	∅ mm	1100	1300	1550
Turning length (every 1000 mm)	mm	3000 - 20000		
Max. weight of workpiece clamped in:				
• chuck	kg	2000		
• centres	kg	18000		
• centres + 1 steady rest	kg	22000		
• centres + 2 steady rests	kg	26000		
<b>Headstock</b>				
Spindle bore diameter	∅ mm	140		
Spindle nose	size	A1 - 15		
Range of continuously variable rotation rates	rpm	4 - 710		
Power of main drive motor	kW	60		
Max. torque on spindle	Nm	17000		
<b>Carriage</b>				
Rapid travel in X and Z axes	mm/min	5000		
Longitudinal travel	mm	3200 for 3000 mm turning length, every 1000 mm		
Cross-wise travel	mm	700	700 + 250 *	700 + 250 *
X-axis ball screw diameter	∅ × pitch mm	50 × 8		
Z-axis ball screw diameter (3000 mm – 5000 mm of turning length)	∅ × pitch mm	80 × 16		
Z-axis drive for 6000 mm to 20000 mm	type	rack-and-pinion, backlash-free *		
Tool system	type	automatic 4-position turret / other *		
<b>Tailstock</b>				
Quill diameter	∅ mm	240		
Quill stroke	mm	200		
<b>Machine tool overall dimensions and weight, approx.</b>				
• Length	mm	2900 + turning length		
• Width	mm	3300		
• Height	mm	2500		
Weight (for 2000 mm turning length)	kg	17000	17800	18600
Increase in weight for 1000 mm of turning length	kg	1900		
* – Optional execution.		Some of the above data can be altered to meet the Customer requirements. Above data are subject to change due to product development, without prior notice.		

# Steady rests for lathes

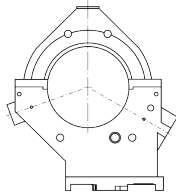
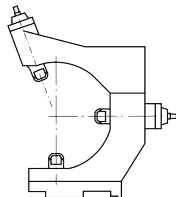
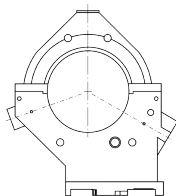
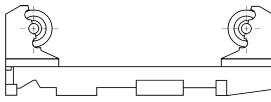
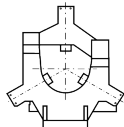
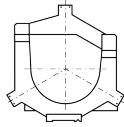
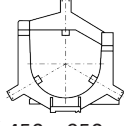
Name	Diameters	Application	Steady rest
Roller steady rest	Ø 250 – 600 mm (TZL 420 CNC, TCF) Ø 600 – 1000 mm (TZL 420 CNC, TCE) Ø 20 – 160 mm (TRP 63, TRP 72) Ø 40 – 400 mm (TRP 93, TRP 110) Ø 160 – 380 mm (TRP 63, TRP 72) Ø 400 – 600 mm (TRP 93, TRP 110) Ø 100 – 400 mm (TCF) Ø 400 – 800 mm (TCF) Ø 700 – 1100 mm (TCF) Ø 250 – 650 mm (TCE) Ø 50 – 450 mm (TCM) Ø 450 – 750 mm (TCM) Ø 450 – 950 mm (TCM)	<ul style="list-style-type: none"> <li>• TZL 420 CNC</li> <li>• TRP Series</li> <li>• TCF Series</li> <li>• TCE Series</li> <li>• TCM Series</li> </ul>	
C – type roller steady rest	Ø 150 – 700 mm (TZL 420 CNC, TCF) Ø 400 – 800 mm (TZL 420 CNC, TCF) Ø 700 – 1000 mm (TZL 420 CNC, TCF)	<ul style="list-style-type: none"> <li>• TZL 420 CNC</li> <li>• TCF Series</li> </ul>	
Hydrostatic steady rest	Ø 600 – 1000 mm (TZL 420 CNC, TCE)	<ul style="list-style-type: none"> <li>• TZL 420 CNC</li> <li>• TCE Series</li> </ul>	
Open-type roller steady rest	Ø 1000 – 1350 mm (TCE) Ø 1000 – 1800 mm (TCE) Ø 1100 – 1600 mm (TCF)	<ul style="list-style-type: none"> <li>• TCE Series</li> <li>• TCF Series</li> </ul>	
Tilting-type roller steady rest	Ø 50 – 450 mm (TRB) Ø 450 – 750 mm (TRB) Ø 450 – 950 mm (TRB)	<ul style="list-style-type: none"> <li>• TRB Series</li> </ul>	 <p>Ø 50 – 450 mm</p>  <p>Ø 450 – 750 mm</p>  <p>Ø 450 – 950 mm</p>